

INSTRUCTION NO. 14138

MODEL 244 CHRYSLER "DAGGER" SAILBOAT

RIGGING INSTRUCTIONS

We, at Chrysler Boat Corporation, congratulate you on your selection of our Model 244 "Dagger" sailboat. These instructions should enable you to identify all the parts involved in rigging and show you their proper location and function on the rigged boat.

Parts List and Nomenclature

Please refer to the photo opposite (Page 3) and note that all parts furnished with your "Dagger" are numbered to correspond with the following list:

PHOTO NO.	QUANTITY	ITEM	CHRYSLER PART NO.
1.	1 ea.	Rudder Assembly	816502
Not shown	1 ea.	Sail, w/bag & Battens	25481
2	1 ea.	Dagger Board	25436
3	3 ea.	Shroud Adjustor	25101
4	1 ea.	Bridle Block	25485
5	1 ea.	Halyard Shackle	25023
6	1 ea.	Shackle, D, 1 1/4	25239
7	1 ea.	Boom Block	25146
8	1 ea.	Clew Outhaul Line (3/16"x60")	829575
9	1 ea.	Bridle (5/16" x 72")	829573
10	1 ea.	Halyard (3/16" x 41')	829574
11	1 ea.	Main Sheet (5/16"x32')	829572
12	1 ea.	Tack down haul 3/16" x 36")	829154
13	2 ea.	Shroud 3/32" x 151 3/4")	816460
14	1 ea.	Forestay (3/32" x 159")	816459
15	1 ea.	Welcome Aboard Card	13543
16	1 ea.	Rigging Instruction	14138
Not shown	1 ea.	Mast assy	816452
Not shown	1 ea.	Boom assy	816453
17	3 ea.	Clevis Pin	25196
17	3 ea.	Cotter pin	25035

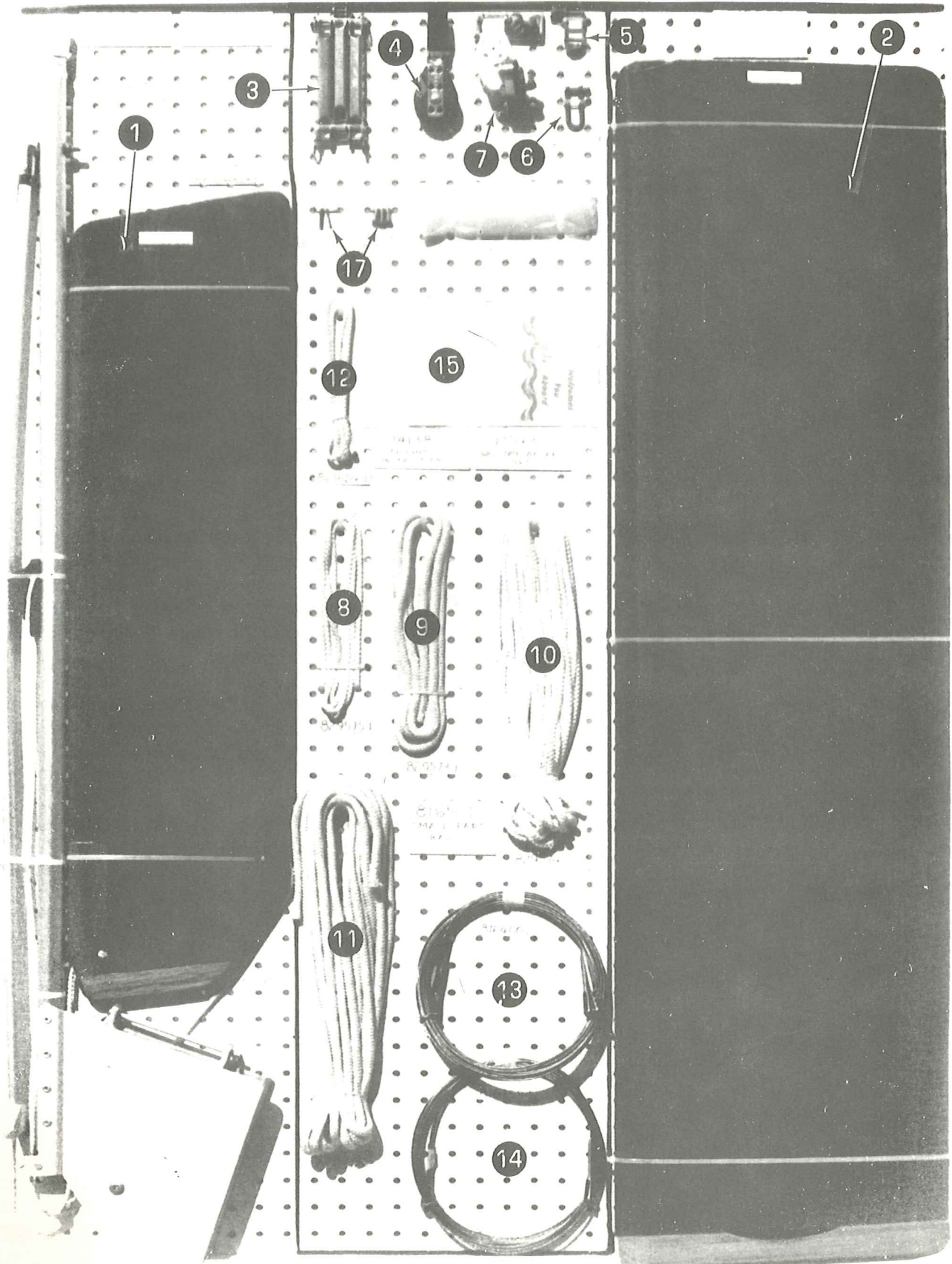

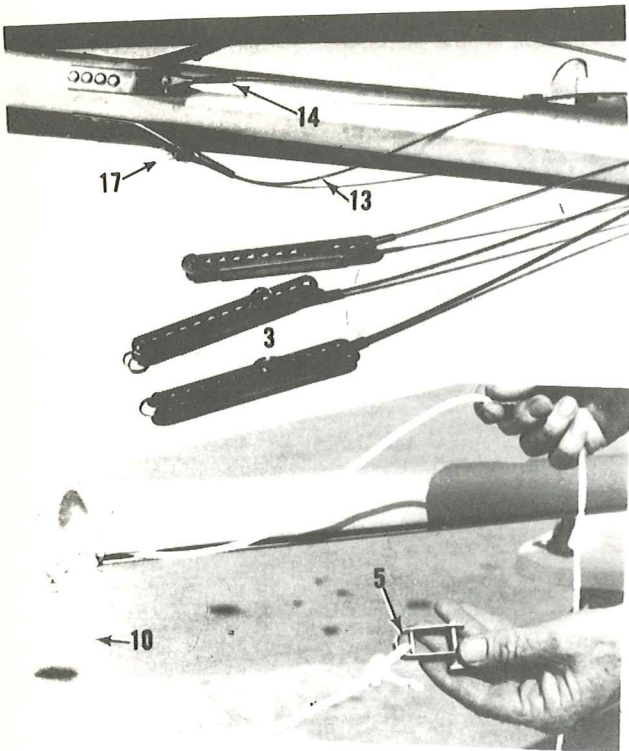

1. Attach the jaw ends of the shrouds and forestay to the tangs on the mast with the clevis pins (17) and cotter pins. The shrouds are both the same length (13) and go to the side tangs. The forestay (14) is a bit longer and goes to the forward tang. Attach a shroud adjuster (3) to each shroud and the forestay. Initially use about the fourth hole down in the adjusters for this attachment.

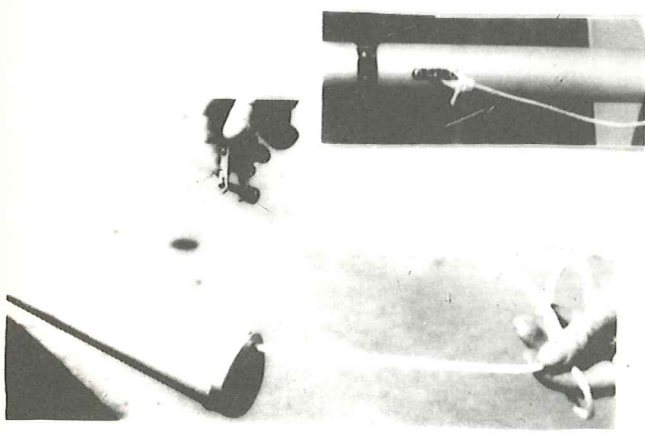

2. Insert one end of the halyard (10) over the sheave in the mast head casting, but under the wire retainer pin, then down through the hole in the mast casting and into the sail groove. Continue this halyard all the way down the sail-groove and out the hole in the mast heel casting. Tie the halyard shackle (5) to the other end of the halyard.

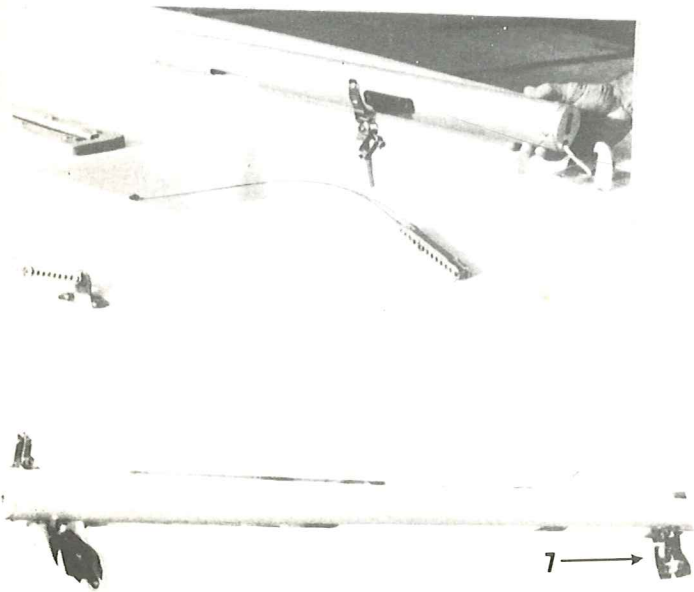

3. Tie the downhaul line (12) to the eyestay on the port side of the mast just below the gooseneck.

4. Lay the mast across the transom with the groove down and the slot in the mast heel casting almost engaged with the hook on the deck plate. Insert the halyard end protruding from the heel casting into the hole in the deck plate and secure it on the cleat in the boat just below the deck plate. Move the mast forward to engage the heel slot with the plate hook, attach the shroud adjusters to the chain plates, then raise the mast head straight up and attach the forestay adjuster to the stem fitting at the forward end of the deck. Note: At this point you should adjust the shroud adjusters by using different clevis pin holes, until they have equal tension and the mast heel is flat on the deck plate. As you look from the side it will appear that the mast is raked way aft at the top, which is correct. The designed rake is approx. 7° aft from the waterline.

5. Attach the main sheet boom block (7) to the track on the under side of the boom. The forward end of the boom casting has a hole into which the gooseneck fits, and the cams and fairlead on the mainsheet boom block are toward the mast.

6. On the aft end of the boom is a block with a becket which will be part of the main sheet system. Take your bridle rope (9) and reeve it through a hole in the gunwale lip near the transom, tie a knot at the end. Now slip your bridle block (4) (the small one) onto the bridle, put the other end thru the hole across the boat and tie a knot.

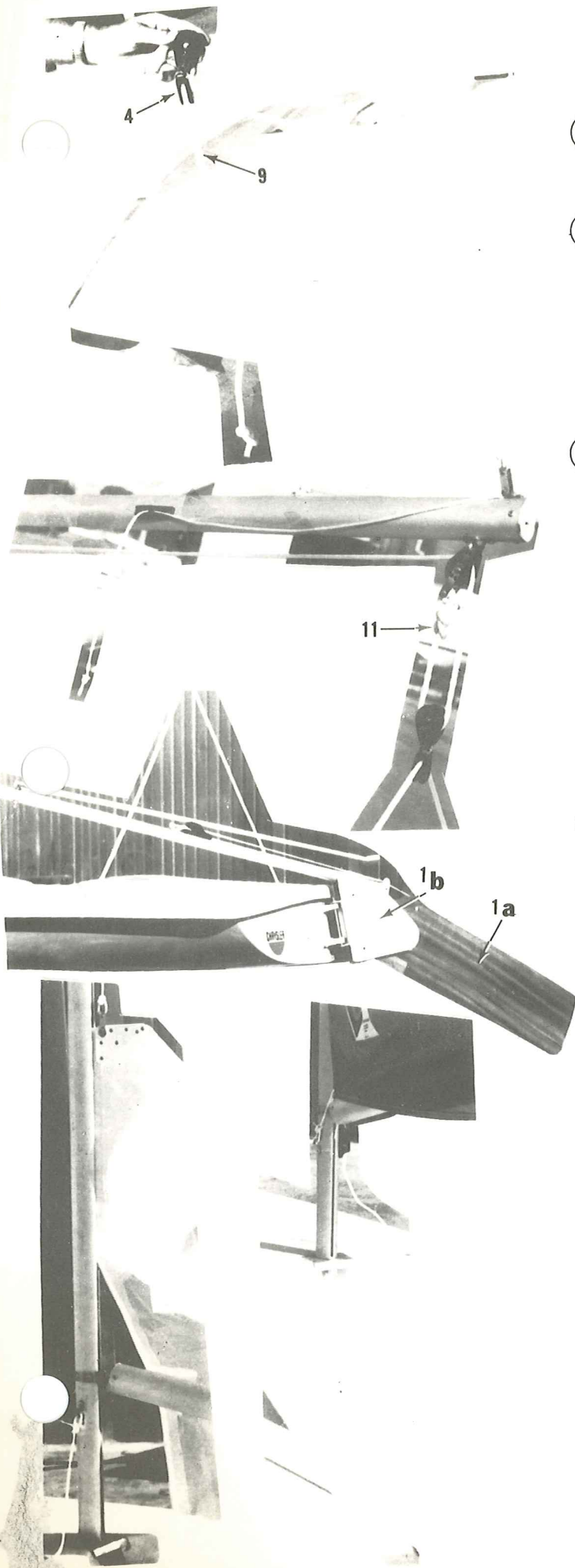

7. Insert the rod on the gooseneck into the forward end of the boom and tie the aft end up using the halyard as a topping lift.
8. Take the main sheet (11) and tie one end to the becket of the block at the end of the boom. Reeve the other end through forward side of the large (upper) block on the traveller, then up over the aft side of the block above the becket, along the underside of the boom, through the sheave on the mainsheet boom block, and through the eye-strap over the cam cleat.
9. Assemble the rudder blade (1a) to the rudder cheeks (1 b) with the bushing and bolt and nut provided. First put the bushing through the pivot hole in the wooden blade, make sure the raising and lowering line is not twisted and runs over the plastic roller so that a pull on one side will raise the blade and a pull on the other side will lower it. Now slide the blade and bushing between the cheeks and secure it with the bolt and nut. Remove the rudder pin, place the rudder over the transom casting, insert the pin from the bottom side and replace the retainer ring. (Note: The tiller must go under the mainsheet bridle.)
10. You now have the standing and running rigging completed and it is time to put up the sail. This can be done either ashore or on the water. Situate the boat so the wind is at or near the bow. Shake out the sail and install the battens. You will note that the batten pockets have elastic in the bottom end to allow you to push the battens in far enough to tuck the outer end under a flap made by the edge of the pocket turned under. Release your halyard shackle from the boom end and engage it into the headboard of the sail. Feed the head of the sail into the entry slot on the mast and then, guiding the sail, raise it to the mast head with the halyard. Cleat off the halyard at the front end of the cockpit. Insert the tack of the sail into the groove below, and by way of, the sail entry slot. Reeve the downhaul line thru the tack grommet and down thru the black clam cleat. Haul down to tighten or ease off to loosen the sail luff. Now use the small shackle (6) thru the grommet at the clew end of the sail to attach it to the sail slide in the boom groove. Tie the clew outhaul line (8) to this same sail slide, lead it through the eye strap at the end of the boom

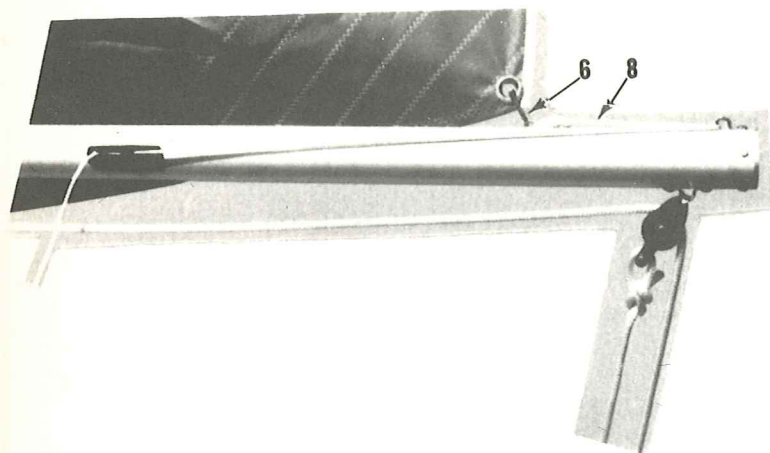

and then forward thru the black clam cleat on the boom side. Haul on this line to tighten the foot of the sail or let it off to loosen the foot. Lay the dagger board (2) in the boat, or partially insert it into the dagger board slot. (Note: If you are already in the water you will have found out if your transom drain plug is closed or not, but if you have rigged on the beach, now is the time to check this plug and the two plugs in the rear of the cockpit to see that they are properly in place.)



Make sure you have an approved personal flotation device for each person aboard. Also a big thirsty sponge and a small plastic bucket are handy to have along.

We recommend that you make up a small tool packet consisting of a pair of pliers, a slot head screw driver, a Phillips head screwdriver, and a pocket knife or similar cutting tool. You may wish to carry in this packet a few spare parts, i.e., any small parts that could be lost or dropped overboard during rigging, and a few pieces of small line to make emergency repairs. Keep this packet with your boat at all times.

Remember to mail your "Welcome Aboard Card."

The following accessories are available to make your sailing more enjoyable.

- Model 244-972 Boom Vang
- 244-943 Bailer (single)
- 244-944 Bailers (pair)
- 244-966 Hiking straps
- 244-967 Cockpit cover
- 159-979 Trailer

"CHRYSLER DAGGER SAILBOAT"

CONTENTS

Pg. No.	<u>Description</u>
2	View of Boat
3	Parts Listing of Boat-Incl. Ref. No's., Part No's, No's. Req'd. & Description
4	Mast Assembly Detail For Complete Mast Ass'y. Order No. 816452 For Individual Parts See Mast Ass'y. Detail
4	Boom Assembly Detail For Complete Mast Ass'y. Order No. 816453 For Individual Parts See Boom Ass'y. Detail
4	Rudder Head & Tiller Assembly Detail For Complete Rudder Head & Tiller Ass'y. Order No. 816502 For Individual Parts See Rudder Head & Tiller Detail

RIGGING BOX ASSEMBLY

REF. NO.	Part No.	No. Req'd.	<u>Description</u>
1	816502	1	Rudder Assembly
2	25481	1	Sail w/bag & Battens (Not Shown)
3	25436	1	Dagger Board
4	25101	3	Shroud Adjustor
5	25485	1	Bridle Block
6	25023	1	Halyard Shackle
7	25239	1	Shackle D 1 1/4
8	25146	1	Boom Block
9	829575	1	Clew Outhaul Line (3/16X60)
10	829573	1	Bridle (5/16X72)
11	829574	1	Halyard (3/16 X41 ft.)
12	829572	1	Main Sheet (5/16 X32 ft.)
13	829154	1	Tack Down Haul (3/16' X36)
14	816460	2	Shroud (3/32 X151 3/4)
15	816459	1	Forestay (3/32 X159)
16	13543	1	Welcome Aboard Card
17	14138	1	Rigging Instruction
18	25196	3	Clevis Pin
19	25035	3	Cotter Pin

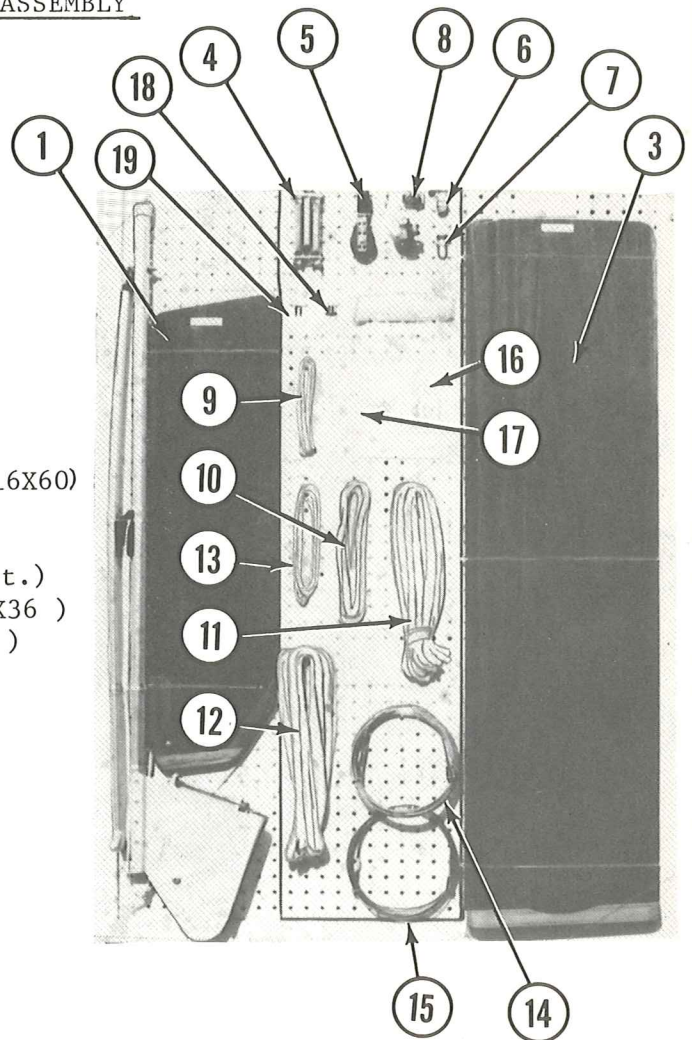

DAGGER

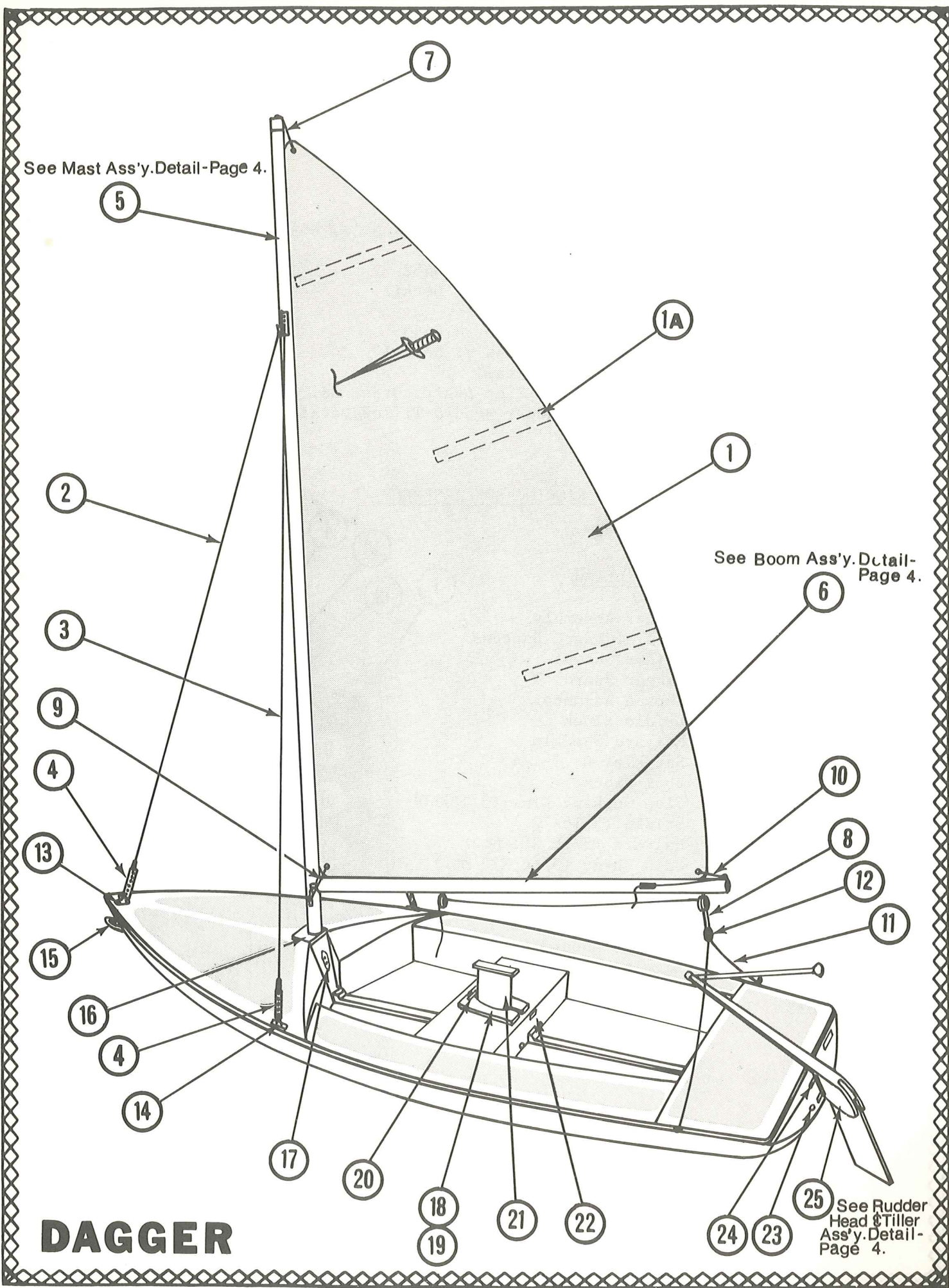

See Mast Ass'y. Detail - Page 4.

See Boom Ass'y. Detail - Page 4.

See Rudder Head & Tiller Ass'y. Detail - Page 4.

DAGGER

<u>REF. NO.</u>	<u>PART NO.</u>	<u>NO. REQ'D.</u>	<u>DESCRIPTION</u>
1	25481	1	Main Sail W/Bag & Battens
1A	85344	3	Battens
2	816459	1	Forestay Ass'y. 159 1/8 (Cont. A & B)
2A	25038	1	Term Swage - Eye (Attaches to Shroud Adjuster)
2B	25037	1	Term Swage - Jaw (Attaches to Tangs on Mast)
3	816460	2	Shroud Ass'y. 151 3/4 (Cont. A & B)
3A	25038	1/Ass'y.	Term Swage - Eye (Attaches to Shroud Adjuster)
3B	25037	1/Ass'y.	Term Swage - Jaw (Attaches to Tangs on Mast)
4	25101	3	Shroud Adjuster
5	816452	1	Mast Assembly (See Det. for Individual Part No.)
6	816453	1	Boom Assembly (See Det. for Individual Part No.)
7	829574	1	Halyard 41 ft.
8	829572	1	Main Sheet 32 ft.
9	829154	1	Down Haul Line 3 ft.
10	829575	1	Out Haul Line 5 ft.
11	829573	1	Bridle 6 ft.
12	25146	1	Bridle Block
13	815888	1	Deck Chain Plate Assembly - Bow
14	816076	2	Pol. Chain Plate Assembly - Port & Starboard
15	24372	1	Bow Eye
16	816554	1	Mast Step Assembly (Contains A-C)
16A	843739	1	Mast Head Pulley Pin (Not Shown)
16B	25204	1	Mast Head Sheave (Not Shown)
16C	25478	1	Mast Step Casting (Not Shown)
17	25086	1	Cleat 3 1/4
18	25475	1	Center Board Trunk Cap - Port
19	25476	1	Center Board Trunk Cap - Starboard
20	829164	1	Snubber Hose
21	25436	1	Dagger Board
22	26970	1	Dagger BIA Plate
23	25249	1	Drain Plug - FG 222
24	25142	1	Transom Casting
25	816502	1	Rudder Heat & Tiller Ass'y. (See Det. for Indiv. Part No.)
	22309	2	Drain Plug (Not Shown - Inside Aft)
	26978	1	Dagger-I.D. Plate (Not Shown - Inside Aft)
	816520	1	Mast & Boom Kit (Cont'd.) (Not Shown)

OPTIONS

816591	1	Hiking Straps
	1	Cockpit Cover
816593	1	Boom Vang
25506	1	Cockpit Bailer (Single)
25506	1	Cockpit Bailer (Double)

MISC. MTRL.

814580	1	Owner Manual Packet
		*Order Gelcoats by the Pound & Paint by the Gal.
*51622		Off-White Gelcoat
800872		Off-White Repair Kit
*51610		Lime-Green Gelcoat
801964		Lime Green Repair Kit
*51514		Light-Blue Gelcoat
801110		Light-Blue Repair Kit

DAGGER

MAST ASSEMBLY

Ref. No.	Part No.	No. Req'd.	Description
	816452	1	Mast Ass'y. (Contains A-G) For Individ. Parts See Below
A	25479	1	Mast Heel Casting
B	844578	1	Mast Head Retainer Pin
C	25434	1	Goose Neck-FG 734
D	25244	1	Seaboard Clam Cleat
E	25127	3	Tang-SM 354-4
F	25110	1	Eye Strap-SM 226
G	816455	1	Mast Head Ass'y. (Cont. G1-G3)
G1	843739	1	Mast Head Pully Pin
G2	25477	1	Mast Head Casting
G3	25204	1	Mast Head Sheave

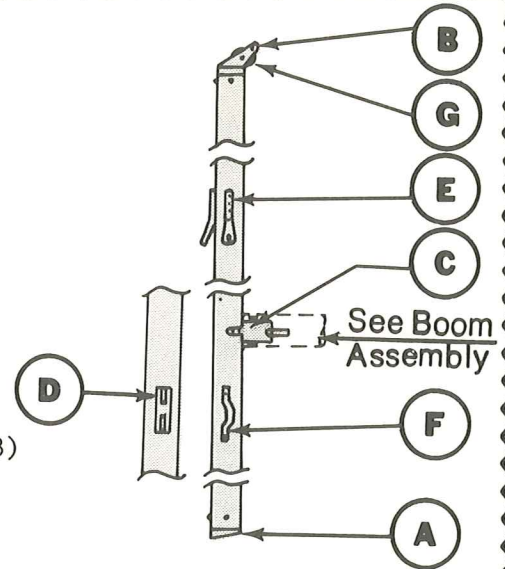

BOOM ASSEMBLY

Ref. No.	Part No.	No. Req'd.	Description
	816453	1	Boom Ass'y. (Contains A-F)
A	844445	1	Main Sheet Track
B	25484	1	Swivel Block w/becket
C	25480	2	Boom End Casting
D	25244	1	Seaboard Clam Cleat
E	25110	2	Eye Strap-SM 226
F	25433	1	Sail Slide

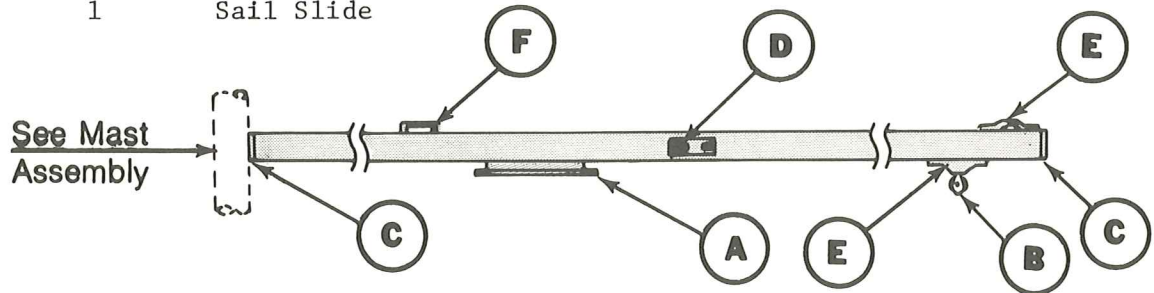

RUDDER&TILLER ASSEMBLY

Ref.No.	Part No.	Qty.	Description
	816502	1	Rudder Head & Tiller Ass'y.
A	844547	1	Tiller Handle Insert
B	830493	1	Rubber Bushing
C	844551	1	Rudder Roller Pin
E	829581	1	Rudder Hold Down Line
F	829576	1	Modified Cleat
G	816497	1	Anod. Tiller Handle
H	816490	1	Anod. Rudder Head Ass'y.
I	815562	1	Tiller Extension
I1	815560	1	Anod. Tiller Extension
I2	25286	1	Swivel Hiking Stick
I3	25183	1	Tiller Ext. Handle
J	25486	1	Rudder Pin
K	25225	1	Ring Keeper
L	24958	1	Chair Leg Tip
M	25483	1	Rudder Blade

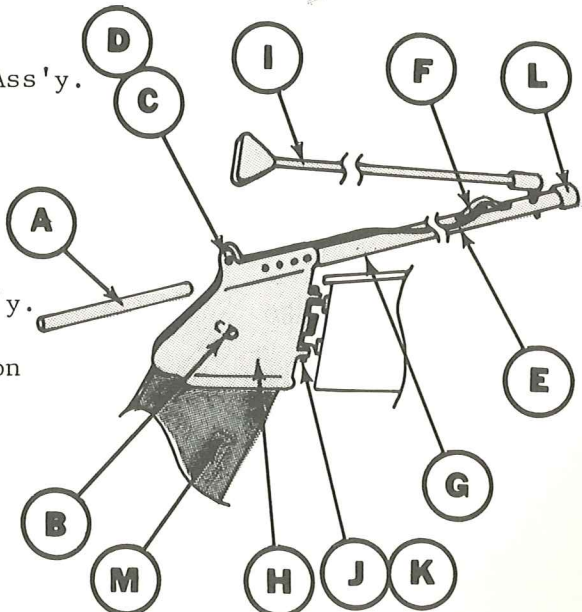

DAGGER